

74AUP2G07

Low-power dual buffer with open-drain output

Rev. 02 — 12 June 2007

Product data sheet

1. General description

The 74AUP2G07 provides two non-inverting buffers with open-drain output. The output of the device is an open drain and can be connected to other open-drain outputs to implement active-LOW wired-OR or active-HIGH wired-AND functions.

Schmitt-trigger action at all inputs makes the circuit tolerant to slower input rise and fall times across the entire V_{CC} range from 0.8 V to 3.6 V.

This device ensures a very low static and dynamic power consumption across the entire V_{CC} range from 0.8 V to 3.6 V.

This device is fully specified for partial power-down applications using I_{OFF} . The I_{OFF} circuitry disables the output, preventing the damaging backflow current through the device when it is powered down.

2. Features

- Wide supply voltage range from 0.8 V to 3.6 V
- High noise immunity
- Complies with JEDEC standards:
 - ◆ JESD8-12 (0.8 V to 1.3 V)
 - ◆ JESD8-11 (0.9 V to 1.65 V)
 - ◆ JESD8-7 (1.2 V to 1.95 V)
 - ◆ JESD8-5 (1.8 V to 2.7 V)
 - ◆ JESD8-B (2.7 V to 3.6 V)
- ESD protection:
 - ◆ HBM JESD22-A114E Class 3A exceeds 5000 V
 - ◆ MM JESD22-A115-A exceeds 200 V
 - ◆ CDM JESD22-C101C exceeds 1000 V
- Low static-power consumption; $I_{CC} = 0.9 \mu\text{A}$ (maximum)
- Latch-up performance exceeds 100 mA per JESD 78 Class II
- Inputs accept voltages up to 3.6 V
- Low noise overshoot and undershoot < 10 % of V_{CC}
- I_{OFF} circuitry provides partial Power-down mode operation
- Multiple package options
- Specified from $-40\text{ }^{\circ}\text{C}$ to $+85\text{ }^{\circ}\text{C}$ and $-40\text{ }^{\circ}\text{C}$ to $+125\text{ }^{\circ}\text{C}$

3. Ordering information

Table 1. Ordering information

Type number	Package			Version
	Temperature range	Name	Description	
74AUP2G07GW	-40 °C to +125 °C	SC-88	plastic surface-mounted package; 6 leads	SOT363
74AUP2G07GM	-40 °C to +125 °C	XSON6	plastic extremely thin small outline package; no leads; 6 terminals; body 1 × 1.45 × 0.5 mm	SOT886
74AUP2G07GF	-40 °C to +125 °C	XSON6	plastic extremely thin small outline package; no leads; 6 terminals; body 1 × 1 × 0.5 mm	SOT891

4. Marking

Table 2. Marking

Type number	Marking code
74AUP2G07GW	p7
74AUP2G07GM	p7
74AUP2G07GF	p7

5. Functional diagram

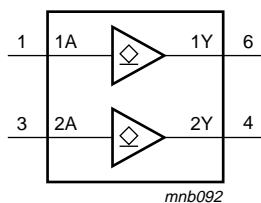

Fig 1. Logic symbol

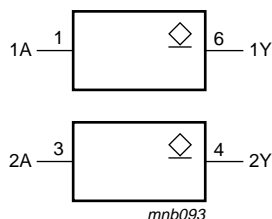

Fig 2. IEC logic symbol

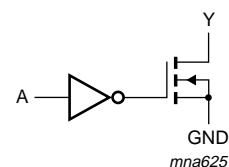
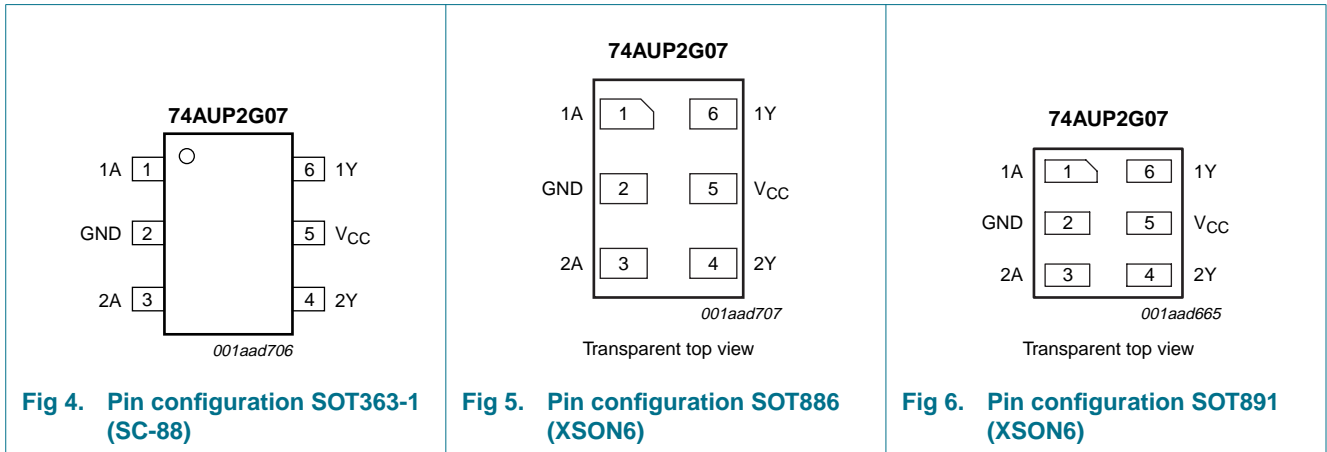

Fig 3. Logic diagram (one gate)

6. Pinning information

6.1 Pinning



6.2 Pin description

Table 3. Pin description

Symbol	Pin	Description
1A	1	data input
GND	2	ground (0 V)
2A	3	data input
2Y	4	data output
V _{CC}	5	supply voltage
1Y	6	data output

7. Functional description

Table 4. Function table^[1]

Input	Output
nA	nY
L	L
H	Z

[1] H = HIGH voltage level;
 L = LOW voltage level;
 Z = high-impedance OFF state.

8. Limiting values

Table 5. Limiting values

In accordance with the Absolute Maximum Rating System (IEC 60134). Voltages are referenced to GND (ground = 0 V).

Symbol	Parameter	Conditions	Min	Max	Unit
V_{CC}	supply voltage		-0.5	+4.6	V
I_{IK}	input clamping current	$V_I < 0$ V	-50	-	mA
V_I	input voltage		[1] -0.5	+4.6	V
I_{OK}	output clamping current	$V_O < 0$ V	-	-50	mA
V_O	output voltage	Active mode and Power-down mode	[1] -0.5	+4.6	V
I_O	output current	$V_O = 0$ V to V_{CC}	-	20	mA
I_{CC}	supply current		-	50	mA
I_{GND}	ground current		-50	-	mA
T_{stg}	storage temperature		-65	+150	°C
P_{tot}	total power dissipation	$T_{amb} = -40$ °C to +125 °C	[2] -	250	mW

[1] The input and output voltage ratings may be exceeded if the input and output current ratings are observed.

[2] For SC-88 package: above 87.5 °C the value of P_{tot} derates linearly with 4.0 mW/K.
For XSON6 packages: above 45 °C the value of P_{tot} derates linearly with 2.4 mW/K.

9. Recommended operating conditions

Table 6. Recommended operating conditions

Symbol	Parameter	Conditions	Min	Max	Unit
V_{CC}	supply voltage		0.8	3.6	V
V_I	input voltage		0	3.6	V
V_O	output voltage	Active mode and Power-down mode	0	3.6	V
T_{amb}	ambient temperature		-40	+125	°C
$\Delta t/\Delta V$	input transition rise and fall rate	$V_{CC} = 0.8$ V to 3.6 V	0	200	ns/V

10. Static characteristics

Table 7. Static characteristics

At recommended operating conditions; voltages are referenced to GND (ground = 0 V).

Symbol	Parameter	Conditions	Min	Typ	Max	Unit
T_{amb} = 25 °C						
V _{IH}	HIGH-level input voltage	V _{CC} = 0.8 V	0.70 × V _{CC}	-	-	V
		V _{CC} = 0.9 V to 1.95 V	0.65 × V _{CC}	-	-	V
		V _{CC} = 2.3 V to 2.7 V	1.6	-	-	V
		V _{CC} = 3.0 V to 3.6 V	2.0	-	-	V
V _{IL}	LOW-level input voltage	V _{CC} = 0.8 V	-	-	0.30 × V _{CC}	V
		V _{CC} = 0.9 V to 1.95 V	-	-	0.35 × V _{CC}	V
		V _{CC} = 2.3 V to 2.7 V	-	-	0.7	V
		V _{CC} = 3.0 V to 3.6 V	-	-	0.9	V
V _{OL}	LOW-level output voltage	V _I = V _{IH} or V _{IL}				
		I _O = 20 μA; V _{CC} = 0.8 V to 3.6 V	-	-	0.1	V
		I _O = 1.1 mA; V _{CC} = 1.1 V	-	-	0.3 × V _{CC}	V
		I _O = 1.7 mA; V _{CC} = 1.4 V	-	-	0.31	V
		I _O = 1.9 mA; V _{CC} = 1.65 V	-	-	0.31	V
		I _O = 2.3 mA; V _{CC} = 2.3 V	-	-	0.31	V
		I _O = 3.1 mA; V _{CC} = 2.3 V	-	-	0.44	V
		I _O = 2.7 mA; V _{CC} = 3.0 V	-	-	0.31	V
I _I	input leakage current	V _I = GND to 3.6 V; V _{CC} = 0 V to 3.6 V	-	-	±0.1	μA
I _{OZ}	OFF-state output current	V _I = V _{IH} ; V _O = 0 V to 3.6 V; V _{CC} = 0 V to 3.6 V	-	-	±0.1	μA
I _{OFF}	power-off leakage current	V _I or V _O = 0 V to 3.6 V; V _{CC} = 0 V	-	-	±0.2	μA
ΔI _{OFF}	additional power-off leakage current	V _I or V _O = 0 V to 3.6 V; V _{CC} = 0 V to 0.2 V	-	-	±0.2	μA
I _{CC}	supply current	V _I = GND or V _{CC} ; I _O = 0 A; V _{CC} = 0.8 V to 3.6 V	-	-	0.5	μA
ΔI _{CC}	additional supply current	V _I = V _{CC} - 0.6 V; I _O = 0 A; V _{CC} = 3.3 V	-	-	40	μA
C _I	input capacitance	V _{CC} = 0 V to 3.6 V; V _I = GND or V _{CC}	-	1.0	-	pF
C _O	output capacitance	output enabled; V _O = GND; V _{CC} = 0 V	-	1.2	-	pF
		output disabled; V _O = GND; V _{CC} = 0 V	-	1.1	-	pF
T_{amb} = -40 °C to +85 °C						
V _{IH}	HIGH-level input voltage	V _{CC} = 0.8 V	0.70 × V _{CC}	-	-	V
		V _{CC} = 0.9 V to 1.95 V	0.65 × V _{CC}	-	-	V
		V _{CC} = 2.3 V to 2.7 V	1.6	-	-	V
		V _{CC} = 3.0 V to 3.6 V	2.0	-	-	V
V _{IL}	LOW-level input voltage	V _{CC} = 0.8 V	-	-	0.30 × V _{CC}	V
		V _{CC} = 0.9 V to 1.95 V	-	-	0.35 × V _{CC}	V
		V _{CC} = 2.3 V to 2.7 V	-	-	0.7	V
		V _{CC} = 3.0 V to 3.6 V	-	-	0.9	V

Table 7. Static characteristics ...continued

At recommended operating conditions; voltages are referenced to GND (ground = 0 V).

Symbol	Parameter	Conditions	Min	Typ	Max	Unit
V _{OL}	LOW-level output voltage	V _I = V _{IH} or V _{IL}				
		I _O = 20 μA; V _{CC} = 0.8 V to 3.6 V	-	-	0.1	V
		I _O = 1.1 mA; V _{CC} = 1.1 V	-	-	0.3 × V _{CC}	V
		I _O = 1.7 mA; V _{CC} = 1.4 V	-	-	0.37	V
		I _O = 1.9 mA; V _{CC} = 1.65 V	-	-	0.35	V
		I _O = 2.3 mA; V _{CC} = 2.3 V	-	-	0.33	V
		I _O = 3.1 mA; V _{CC} = 2.3 V	-	-	0.45	V
		I _O = 2.7 mA; V _{CC} = 3.0 V	-	-	0.33	V
I _O = 4.0 mA; V _{CC} = 3.0 V	-	-	0.45	V		
I _I	input leakage current	V _I = GND to 3.6 V; V _{CC} = 0 V to 3.6 V	-	-	±0.5	μA
I _{OZ}	OFF-state output current	V _I = V _{IH} ; V _O = 0 V to 3.6 V; V _{CC} = 0 V to 3.6 V	-	-	±0.5	μA
I _{OFF}	power-off leakage current	V _I or V _O = 0 V to 3.6 V; V _{CC} = 0 V	-	-	±0.5	μA
ΔI _{OFF}	additional power-off leakage current	V _I or V _O = 0 V to 3.6 V; V _{CC} = 0 V to 0.2 V	-	-	±0.6	μA
I _{CC}	supply current	V _I = GND or V _{CC} ; I _O = 0 A; V _{CC} = 0.8 V to 3.6 V	-	-	0.9	μA
ΔI _{CC}	additional supply current	V _I = V _{CC} - 0.6 V; I _O = 0 A; V _{CC} = 3.3 V	-	-	50	μA
T_{amb} = -40 °C to +125 °C						
V _{IH}	HIGH-level input voltage	V _{CC} = 0.8 V	0.75 × V _{CC}	-	-	V
		V _{CC} = 0.9 V to 1.95 V	0.70 × V _{CC}	-	-	V
		V _{CC} = 2.3 V to 2.7 V	1.6	-	-	V
		V _{CC} = 3.0 V to 3.6 V	2.0	-	-	V
V _{IL}	LOW-level input voltage	V _{CC} = 0.8 V	-	-	0.25 × V _{CC}	V
		V _{CC} = 0.9 V to 1.95 V	-	-	0.30 × V _{CC}	V
		V _{CC} = 2.3 V to 2.7 V	-	-	0.7	V
		V _{CC} = 3.0 V to 3.6 V	-	-	0.9	V
V _{OL}	LOW-level output voltage	V _I = V _{IH} or V _{IL}				
		I _O = 20 μA; V _{CC} = 0.8 V to 3.6 V	-	-	0.11	V
		I _O = 1.1 mA; V _{CC} = 1.1 V	-	-	0.33 × V _{CC}	V
		I _O = 1.7 mA; V _{CC} = 1.4 V	-	-	0.41	V
		I _O = 1.9 mA; V _{CC} = 1.65 V	-	-	0.39	V
		I _O = 2.3 mA; V _{CC} = 2.3 V	-	-	0.36	V
		I _O = 3.1 mA; V _{CC} = 2.3 V	-	-	0.50	V
		I _O = 2.7 mA; V _{CC} = 3.0 V	-	-	0.36	V
I _O = 4.0 mA; V _{CC} = 3.0 V	-	-	0.50	V		
I _I	input leakage current	V _I = GND to 3.6 V; V _{CC} = 0 V to 3.6 V	-	-	±0.75	μA
I _{OZ}	OFF-state output current	V _I = V _{IH} ; V _O = 0 V to 3.6 V; V _{CC} = 0 V to 3.6 V	-	-	±0.75	μA
I _{OFF}	power-off leakage current	V _I or V _O = 0 V to 3.6 V; V _{CC} = 0 V	-	-	±0.75	μA

Table 7. Static characteristics ...continued

At recommended operating conditions; voltages are referenced to GND (ground = 0 V).

Symbol	Parameter	Conditions	Min	Typ	Max	Unit
ΔI_{OFF}	additional power-off leakage current	V_I or $V_O = 0$ V to 3.6 V; $V_{CC} = 0$ V to 0.2 V	-	-	± 0.75	μ A
I_{CC}	supply current	$V_I = GND$ or V_{CC} ; $I_O = 0$ A; $V_{CC} = 0.8$ V to 3.6 V	-	-	1.4	μ A
ΔI_{CC}	additional supply current	$V_I = V_{CC} - 0.6$ V; $I_O = 0$ A; $V_{CC} = 3.3$ V	-	-	75	μ A

11. Dynamic characteristics

Table 8. Dynamic characteristicsVoltages are referenced to GND (ground = 0 V); for test circuit see [Figure 8](#).

Symbol	Parameter	Conditions	25 °C			-40 °C to +125 °C			Unit
			Min	Typ ^[1]	Max	Min	Max (85 °C)	Max (125 °C)	

 $C_L = 5$ pF

t_{pd}	propagation delay	nA to nY; see Figure 7 ^[2]							
		$V_{CC} = 0.8$ V	-	11.6	-	-	-	-	ns
		$V_{CC} = 1.1$ V to 1.3 V	2.1	4.1	7.5	1.7	9.1	10.0	ns
		$V_{CC} = 1.4$ V to 1.6 V	1.6	3.0	5.1	1.3	6.1	6.7	ns
		$V_{CC} = 1.65$ V to 1.95 V	1.6	2.7	4.0	1.2	5.0	5.5	ns
		$V_{CC} = 2.3$ V to 2.7 V	1.1	2.1	3.2	0.9	4.0	4.4	ns
		$V_{CC} = 3.0$ V to 3.6 V	1.4	2.2	2.8	1.1	3.3	3.6	ns

 $C_L = 10$ pF

t_{pd}	propagation delay	nA to nY; see Figure 7 ^[2]							
		$V_{CC} = 0.8$ V	-	14.7	-	-	-	-	ns
		$V_{CC} = 1.1$ V to 1.3 V	3.0	5.1	9.0	2.4	11.2	12.3	ns
		$V_{CC} = 1.4$ V to 1.6 V	2.3	3.8	6.1	2.0	7.4	8.1	ns
		$V_{CC} = 1.65$ V to 1.95 V	2.4	3.6	4.8	1.8	6.1	6.7	ns
		$V_{CC} = 2.3$ V to 2.7 V	1.7	2.8	3.8	1.3	4.8	5.3	ns
		$V_{CC} = 3.0$ V to 3.6 V	2.2	3.1	4.2	1.6	4.5	5.0	ns

 $C_L = 15$ pF

t_{pd}	propagation delay	nA to nY; see Figure 7 ^[2]							
		$V_{CC} = 0.8$ V	-	17.7	-	-	-	-	ns
		$V_{CC} = 1.1$ V to 1.3 V	3.5	6.1	10.4	3.2	13.1	14.5	ns
		$V_{CC} = 1.4$ V to 1.6 V	3.0	4.5	6.8	2.6	8.6	9.4	ns
		$V_{CC} = 1.65$ V to 1.95 V	2.8	4.4	6.7	2.2	7.8	8.6	ns
		$V_{CC} = 2.3$ V to 2.7 V	2.4	3.4	4.5	1.9	5.3	5.8	ns
		$V_{CC} = 3.0$ V to 3.6 V	2.2	4.0	5.7	1.9	6.1	6.7	ns

 $C_L = 30$ pF

Table 8. Dynamic characteristics ...continued

Voltages are referenced to GND (ground = 0 V); for test circuit see [Figure 8](#).

Symbol	Parameter	Conditions	25 °C			–40 °C to +125 °C			Unit
			Min	Typ ^[1]	Max	Min	Max (85 °C)	Max (125 °C)	
t_{pd}	propagation delay	nA to nY; see Figure 7 ^[2]							
		$V_{CC} = 0.8\text{ V}$	-	26.7	-	-	-	-	ns
		$V_{CC} = 1.1\text{ V to }1.3\text{ V}$	4.8	9.0	15.6	4.3	18.8	20.7	ns
		$V_{CC} = 1.4\text{ V to }1.6\text{ V}$	4.1	6.7	9.4	3.7	11.8	13.0	ns
		$V_{CC} = 1.65\text{ V to }1.95\text{ V}$	3.8	6.8	9.7	3.2	11.0	12.1	ns
		$V_{CC} = 2.3\text{ V to }2.7\text{ V}$	3.7	5.2	6.7	3.0	7.1	7.8	ns
		$V_{CC} = 3.0\text{ V to }3.6\text{ V}$	3.6	6.4	9.7	2.8	10.4	11.4	ns

Table 8. Dynamic characteristics ...continued

Voltages are referenced to GND (ground = 0 V); for test circuit see [Figure 8](#).

Symbol	Parameter	Conditions	25 °C			-40 °C to +125 °C			Unit
			Min	Typ ^[1]	Max	Min	Max (85 °C)	Max (125 °C)	
$C_L = 5 \text{ pF}, 10 \text{ pF}, 15 \text{ pF}$ and 30 pF									
C_{PD}	power dissipation capacitance	$f_i = 1 \text{ MHz}; V_I = \text{GND to } V_{CC}$ ^{[3][4]}							
		$V_{CC} = 0.8 \text{ V}$	-	0.7	-	-	-	-	pF
		$V_{CC} = 1.1 \text{ V to } 1.3 \text{ V}$	-	0.7	-	-	-	-	pF
		$V_{CC} = 1.4 \text{ V to } 1.6 \text{ V}$	-	0.7	-	-	-	-	pF
		$V_{CC} = 1.65 \text{ V to } 1.95 \text{ V}$	-	0.7	-	-	-	-	pF
		$V_{CC} = 2.3 \text{ V to } 2.7 \text{ V}$	-	0.9	-	-	-	-	pF
		$V_{CC} = 3.0 \text{ V to } 3.6 \text{ V}$	-	1.2	-	-	-	-	pF

- [1] All typical values are measured at nominal V_{CC} .
- [2] t_{pd} is the same as t_{PZL} and t_{PLZ} .
- [3] All specified values are the average typical values over all stated loads.
- [4] C_{PD} is used to determine the dynamic power dissipation (P_D in μW).
- $$P_D = C_{PD} \times V_{CC}^2 \times f_i \times N + \Sigma(C_L \times V_{CC}^2 \times f_o)$$
- where:
- f_i = input frequency in MHz;
 - f_o = output frequency in MHz;
 - C_L = output load capacitance in pF;
 - V_{CC} = supply voltage in V;
 - N = number of inputs switching;
 - $\Sigma(C_L \times V_{CC}^2 \times f_o)$ = sum of the outputs.

12. Waveforms

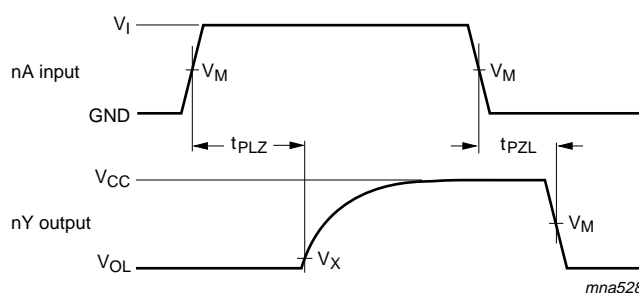

Measurement points are given in [Table 9](#).

Logic level: V_{OL} is the typical output voltage drops that occur with the output load.

Fig 7. The data input (nA) to output (nY) propagation delays

Table 9. Measurement points

Supply voltage	Input	Output	
V_{CC}	V_M	V_M	V_X
0.8 V to 1.6 V	$0.5 \times V_{CC}$	$0.5 \times V_{CC}$	$V_{OL} + 0.1 \text{ V}$
1.65 V to 2.7 V	$0.5 \times V_{CC}$	$0.5 \times V_{CC}$	$V_{OL} + 0.15 \text{ V}$
3.0 V to 3.6 V	$0.5 \times V_{CC}$	$0.5 \times V_{CC}$	$V_{OL} + 0.3 \text{ V}$

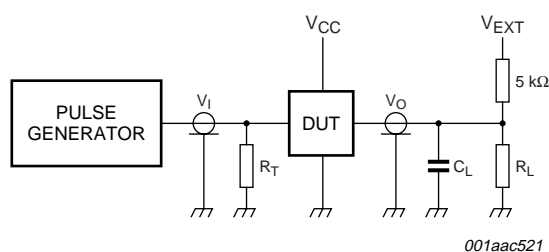

Test data is given in [Table 10](#).

Definitions for test circuit:

R_L = Load resistance.

C_L = Load capacitance including jig and probe capacitance.

R_T = Termination resistance should be equal to the output impedance Z_o of the pulse generator.

V_{EXT} = External voltage for measuring switching times.

Fig 8. Load circuitry for switching times

Table 10. Test data

Supply voltage	Input		Load		V_{EXT}		
V_{CC}	V_I	t_r, t_f	C_L	R_L [1]	t_{PLH}, t_{PHL}	t_{PZH}, t_{PHZ}	t_{PZL}, t_{PLZ}
0.8 V to 3.6 V	V_{CC}	$\leq 3 \text{ ns}$	5 pF, 10 pF, 15 pF and 30 pF	5 kΩ or 1 MΩ	open	GND	$2 \times V_{CC}$

[1] For measuring enable and disable times $R_L = 5 \text{ k}\Omega$, for measuring propagation delays, set-up and hold times and pulse width $R_L = 1 \text{ M}\Omega$.

13. Package outline

Plastic surface-mounted package; 6 leads

SOT363

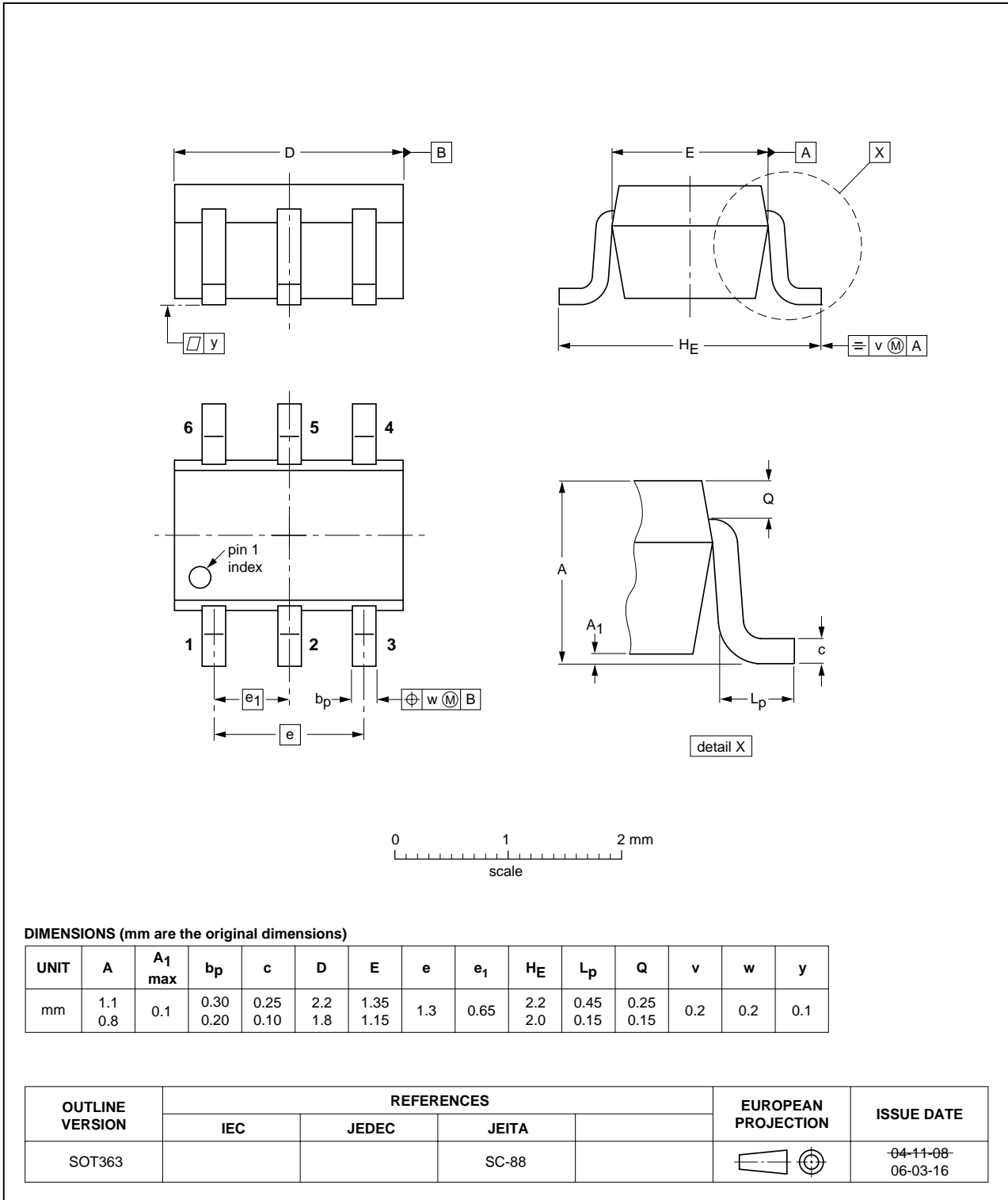

Fig 9. Package outline SOT363 (SC-88)

XSON6: plastic extremely thin small outline package; no leads; 6 terminals; body 1 x 1.45 x 0.5 mm

SOT886

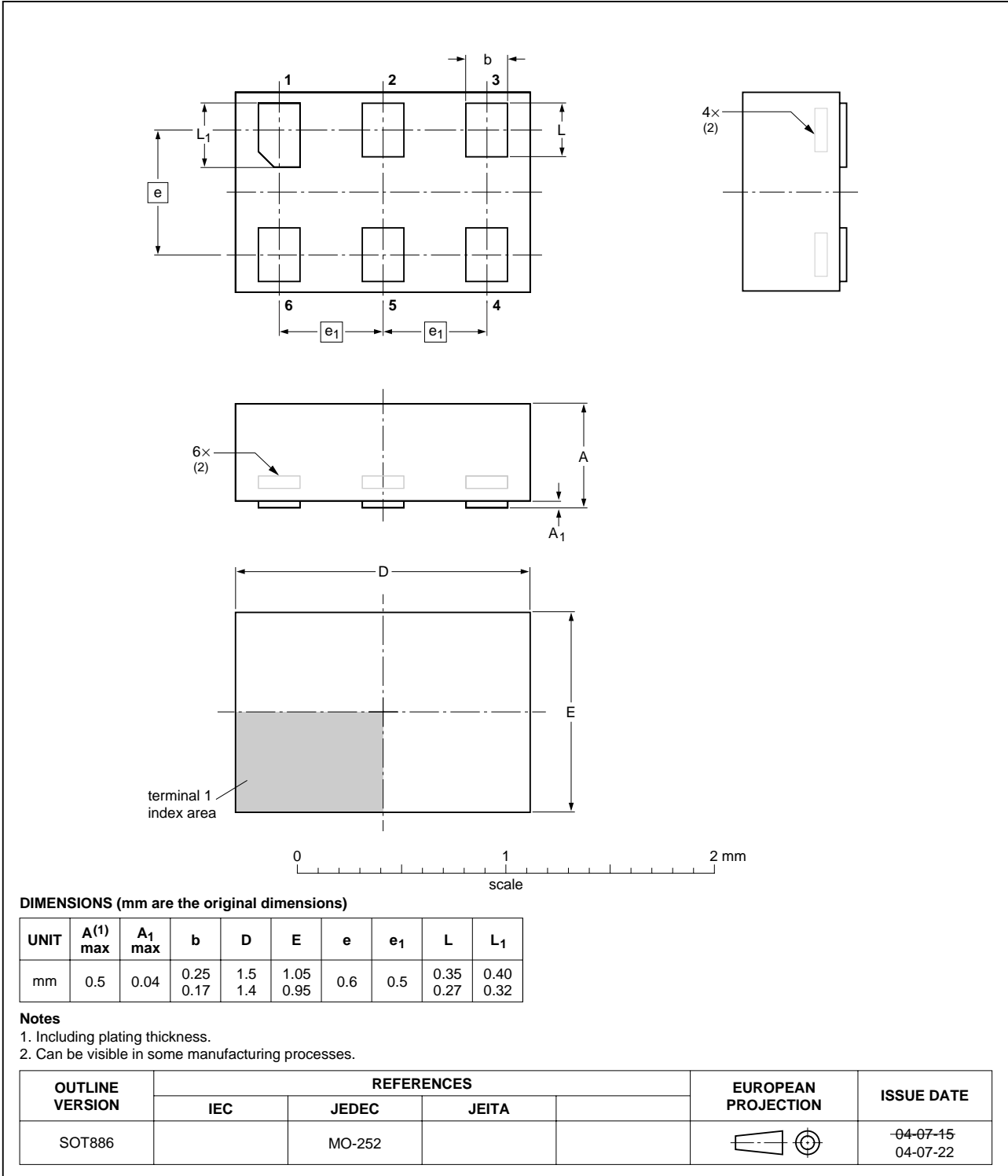

Fig 10. Package outline SOT886 (XSON6)

XSON6: plastic extremely thin small outline package; no leads; 6 terminals; body 1 x 1 x 0.5 mm

SOT891

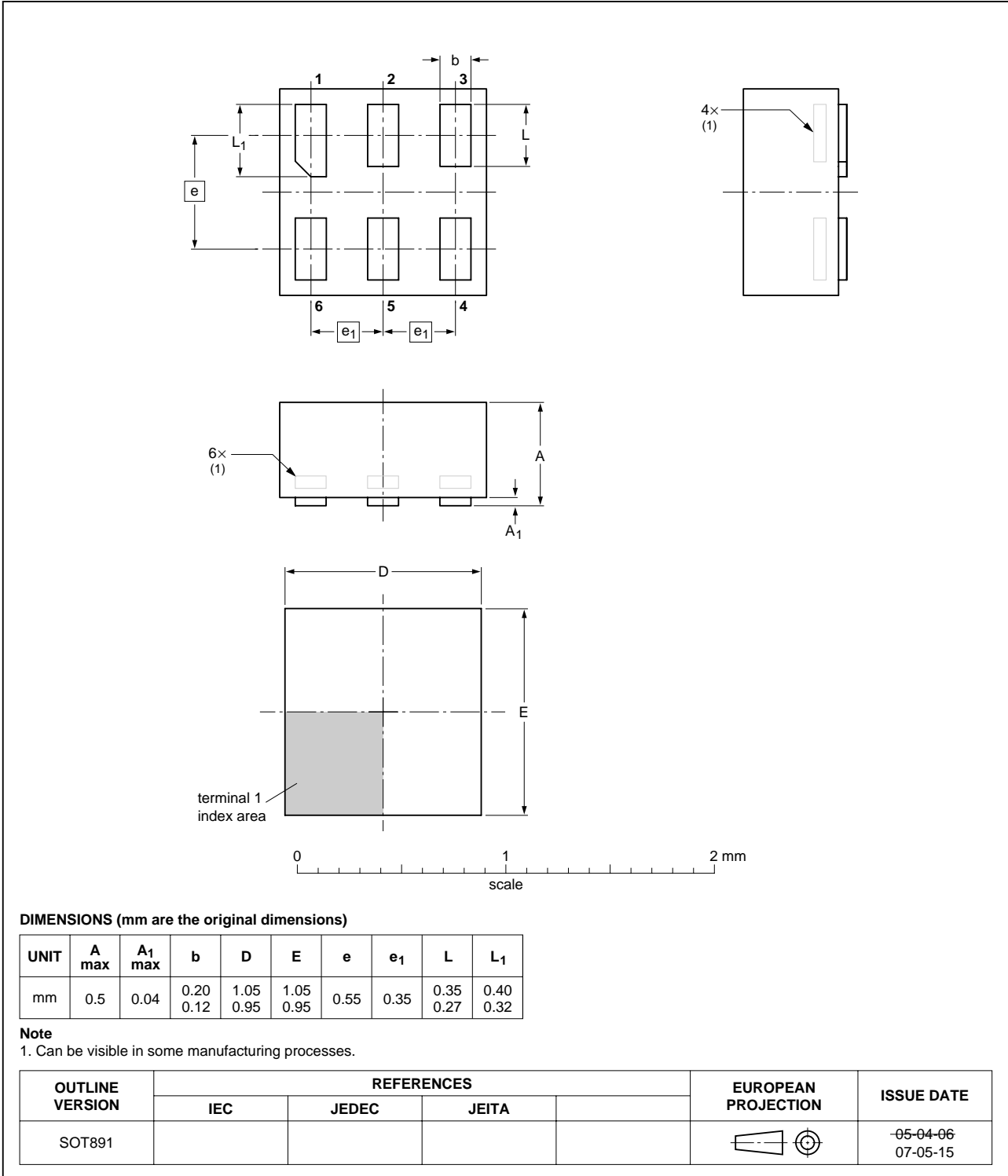

Fig 11. Package outline SOT891 (XSON6)

14. Abbreviations

Table 11. Abbreviations

Acronym	Description
CDM	Charged Device Model
CMOS	Complementary Metal Oxide Semiconductor
DUT	Device Under Test
ESD	ElectroStatic Discharge
HBM	Human Body Model
MM	Machine Model
TTL	Transistor-Transistor Logic

15. Revision history

Table 12. Revision history

Document ID	Release date	Data sheet status	Change notice	Supersedes
74AUP2G07_2	20070612	Product data sheet	-	74AUP2G07_1
Modifications:	<ul style="list-style-type: none"> Added I_{OZ} in Section 10, Table 7 			
74AUP2G07_1	20061121	Product data sheet	-	-

16. Legal information

16.1 Data sheet status

Document status ^{[1][2]}	Product status ^[3]	Definition
Objective [short] data sheet	Development	This document contains data from the objective specification for product development.
Preliminary [short] data sheet	Qualification	This document contains data from the preliminary specification.
Product [short] data sheet	Production	This document contains the product specification.

[1] Please consult the most recently issued document before initiating or completing a design.

[2] The term 'short data sheet' is explained in section "Definitions".

[3] The product status of device(s) described in this document may have changed since this document was published and may differ in case of multiple devices. The latest product status information is available on the Internet at URL <http://www.nxp.com>.

16.2 Definitions

Draft — The document is a draft version only. The content is still under internal review and subject to formal approval, which may result in modifications or additions. NXP Semiconductors does not give any representations or warranties as to the accuracy or completeness of information included herein and shall have no liability for the consequences of use of such information.

Short data sheet — A short data sheet is an extract from a full data sheet with the same product type number(s) and title. A short data sheet is intended for quick reference only and should not be relied upon to contain detailed and full information. For detailed and full information see the relevant full data sheet, which is available on request via the local NXP Semiconductors sales office. In case of any inconsistency or conflict with the short data sheet, the full data sheet shall prevail.

16.3 Disclaimers

General — Information in this document is believed to be accurate and reliable. However, NXP Semiconductors does not give any representations or warranties, expressed or implied, as to the accuracy or completeness of such information and shall have no liability for the consequences of use of such information.

Right to make changes — NXP Semiconductors reserves the right to make changes to information published in this document, including without limitation specifications and product descriptions, at any time and without notice. This document supersedes and replaces all information supplied prior to the publication hereof.

Suitability for use — NXP Semiconductors products are not designed, authorized or warranted to be suitable for use in medical, military, aircraft, space or life support equipment, nor in applications where failure or

malfunction of a NXP Semiconductors product can reasonably be expected to result in personal injury, death or severe property or environmental damage. NXP Semiconductors accepts no liability for inclusion and/or use of NXP Semiconductors products in such equipment or applications and therefore such inclusion and/or use is at the customer's own risk.

Applications — Applications that are described herein for any of these products are for illustrative purposes only. NXP Semiconductors makes no representation or warranty that such applications will be suitable for the specified use without further testing or modification.

Limiting values — Stress above one or more limiting values (as defined in the Absolute Maximum Ratings System of IEC 60134) may cause permanent damage to the device. Limiting values are stress ratings only and operation of the device at these or any other conditions above those given in the Characteristics sections of this document is not implied. Exposure to limiting values for extended periods may affect device reliability.

Terms and conditions of sale — NXP Semiconductors products are sold subject to the general terms and conditions of commercial sale, as published at <http://www.nxp.com/profile/terms>, including those pertaining to warranty, intellectual property rights infringement and limitation of liability, unless explicitly otherwise agreed to in writing by NXP Semiconductors. In case of any inconsistency or conflict between information in this document and such terms and conditions, the latter will prevail.

No offer to sell or license — Nothing in this document may be interpreted or construed as an offer to sell products that is open for acceptance or the grant, conveyance or implication of any license under any copyrights, patents or other industrial or intellectual property rights.

16.4 Trademarks

Notice: All referenced brands, product names, service names and trademarks are the property of their respective owners.

17. Contact information

For additional information, please visit: <http://www.nxp.com>

For sales office addresses, send an email to: salesaddresses@nxp.com

18. Contents

1	General description	1
2	Features	1
3	Ordering information	2
4	Marking	2
5	Functional diagram	2
6	Pinning information	3
6.1	Pinning	3
6.2	Pin description	3
7	Functional description	3
8	Limiting values	4
9	Recommended operating conditions	4
10	Static characteristics	5
11	Dynamic characteristics	7
12	Waveforms	9
13	Package outline	11
14	Abbreviations	14
15	Revision history	14
16	Legal information	15
16.1	Data sheet status	15
16.2	Definitions	15
16.3	Disclaimers	15
16.4	Trademarks	15
17	Contact information	15
18	Contents	16

Please be aware that important notices concerning this document and the product(s) described herein, have been included in section 'Legal information'.

founded by

PHILIPS

© NXP B.V. 2007.

All rights reserved.

For more information, please visit: <http://www.nxp.com>

For sales office addresses, please send an email to: salesaddresses@nxp.com

Date of release: 12 June 2007

Document identifier: 74AUP2G07_2